



Public Data-based Report



Validation Report Service

Cryo-EM Map Validation Report

Report to assess Cryo-EM Volume Map at Level(s) 1, 0

This report has been generated based on data publicly available at [EMDB](#).

Basic Entry Information:

EMDB ID: [EMD-44254](#)

Title: Consensus map: CW Flagellar Switch Complex - FliF, FliG, FliM, and FliN forming the C-ring from Salmonella

Authors: [See EMDB entry link](#)

Deposited on: 2024-03-25T00:00:00

Reported Resolution: 7.01 Å

Contact Us:

Instruct Image Processing Center ([I²PC](#))

Biocomputing Unit ([BCU](#))

i2pc@cnb.csic.es

[VRS Website](#)

National Center for Biotechnology (CNB)
St/ Darwin, 3 (Autonomous University of Madrid)
28049 Cantoblanco, Madrid (Spain)

Last update: **April 29, 2026, 6:24pm**

Context

Cryo-electron microscopy is currently one of the most active techniques in Structural Biology. The number of maps deposited at the [Electron Microscopy Data Bank](#) is rapidly growing every year and keeping the quality of the submitted maps is essential to maintain the scientific quality of the field. The ultimate quality measure is the consistency of the map and an atomic model. However, this is only possible for high resolution maps. Over the years there have been many suggestions about validation measures of 3DEM maps. Unfortunately, most of these measures are not currently in use for their spread in multiple software tools and the associated difficulty to access them. To alleviate this problem, we made available a validation grading system that evaluate the information provided to assess the map.

This system grades a map from 0 to 5 depending on the amount of information available. In this way, a map could be validated at Level 0 (the deposited map), 1 (two half maps), 2 (2D classes), 3 (particles), 4 (... + angular assignment), 5 (... + micrographs and coordinates). In addition, we can have three optional qualifiers: A (... + atomic model), W (... + image processing workflow), and O (... + other techniques). To know more about this service read this [paper](#)

This Validation Report Service uses Scipion (see this [link](#) for more detail) as workflow engine and ChimeraX (see this [link](#) for more detail) to generate the 3D views. For more information about the different methods and softwares used for this report, see the references [here](#).



Summarized overall quality

The map seems to be well centered. There seems to be a problem with the suggested threshold (see Sec. 2.2). There seems to be a problem with the map's background (see Sec. 2.3). There seems to be a problem with its B-factor (see Sec. 2.4). There seems to be a problem with its local B-factor (see Sec. 2.6). The resolution does not seem to be uniform in all directions (see Sec. 4.6).

The average resolution of the map estimated by various methods goes from 1.0Å to 16.7Å with an average of 10.0Å. The resolution reported by the user was 7.0Å. The resolution reported may be over-estimated.

The overall score (passing tests) of this report is 5 out of 13 evaluable items.

0.a Mass analysis	Sec. 2.1	OK
0.b Mask analysis	Sec. 2.2	2 warnings
0.c Background analysis	Sec. 2.3	2 warnings
0.d B-factor analysis	Sec. 2.4	1 warnings
0.e DeepRes	Sec. 2.5	Could not be measured
0.f LocBfactor	Sec. 2.6	1 warnings
0.g LocOccupancy	Sec. 2.7	OK
0.h Deep hand	Sec. 2.8	Does not apply
1.a Global resolution	Sec. 4.1	3 warnings
1.b FSC permutation	Sec. 4.2	1 warnings
1.c Blocres	Sec. 4.3	1 warnings
1.d Resmap	Sec. 4.4	Could not be measured
1.e MonoRes	Sec. 4.5	OK
1.f MonoDir	Sec. 4.6	2 warnings
1.g FSO	Sec. 4.7	OK
1.h FSC3D	Sec. 4.8	OK

Summary of the warnings across sections.

Section 2.2 (0.b Mask analysis)

1. **There might be a problem with noise and artifacts, because the average noise blob has a volume of 8.615125 Å³.**
2. **There might be a problem in the construction of the mask, because the overlap is smaller than 0.75. A common reason is that the suggested threshold causes too many disconnected components.**

Section 2.3 (0.c Background analysis)

1. **The null hypothesis that the background mean is 0 has been rejected because the p-value of the comparison is smaller than 0.001**
2. **There is a significant proportion of outlier values in the background (cdf5 ratio=11986.81)**

Section 2.4 (0.d B-factor analysis)

1. **The B-factor is out of the interval [-300,0].**

Section 2.6 (0.f LocBfactor)

1. **The median B-factor is out of the interval [-300,0]**

Section 4.1 (1.a Global resolution)

1. **The reported resolution, 7.01 Å, is particularly high with respect to the resolution calculated by the FSC, 10.61 Å**
2. **The reported resolution, 7.01 Å, is particularly high with respect to the resolution calculated by the DPR, 9.20Å.**
3. **The reported resolution, 7.01 Å, is particularly high with respect to the resolution calculated by the SSNR, 13.18Å.**

Section 4.2 (1.b FSC permutation)

1. **The reported resolution, 7.01 Å, is particularly high with respect to the resolution calculated by the FSC permutation, 9.21 Å**

Section 4.3 (1.c Blocres)

1. **The reported resolution, 7.01 Å, is particularly high with respect to the local resolution distribution. It occupies the 0.00 percentile**

Section 4.6 (1.f MonoDir)

1. The distribution of best resolution is not uniform in all directions. The associated p-value is 0.000000.
2. The resolution reported by the user, 7.01Å, is at least 80% smaller than the average directional resolution, 10.27 Å.

Contents

1	Input data	7
2	Level 0 analysis	14
2.1	Level 0.a Mass analysis	14
2.2	Level 0.b Mask analysis	15
2.3	Level 0.c Background analysis	19
2.4	Level 0.d B-factor analysis	20
2.5	Level 0.e Local resolution with DeepRes	23
2.6	Level 0.f Local B-factor	23
2.7	Level 0.g Local Occupancy	26
2.8	Level 0.h Hand correction	29
3	Half maps	30
4	Level 1 analysis	33
4.1	Level 1.a Global resolution	33
4.2	Level 1.b FSC permutation	36
4.3	Level 1.c Local resolution with Blocres	37
4.4	Level 1.d Local resolution with Resmap	40
4.5	Level 1.e Local resolution with MonoRes	40
4.6	Level 1.f Local and directional resolution with MonoDir	43
4.7	Level 1.g Fourier Shell Occupancy	46
4.8	Level 1.h Fourier Shell Correlation 3D	48

1 Input data

Input map: emd_44254.map

SHA256 hash: e8141ca28881aabe46f832fac18aef84192a9b57817555070e9be21e7bac3334

Voxel size: 2.050000 (Å)

Visualization threshold: 0.253000

Resolution estimated by user: 7.01

Orthogonal slices of the input map

Explanation:

In the orthogonal slices of the map, the noise outside the protein should not have any structure (stripes going out, small blobs, particularly high or low densities, ...)

Results:

See Fig. 1.

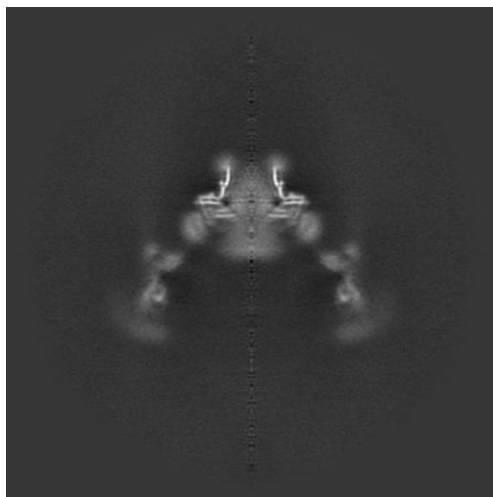

(a) X Slice 256

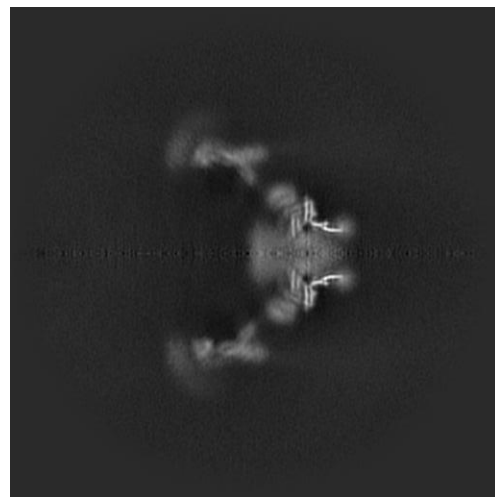

(b) Y Slice 256

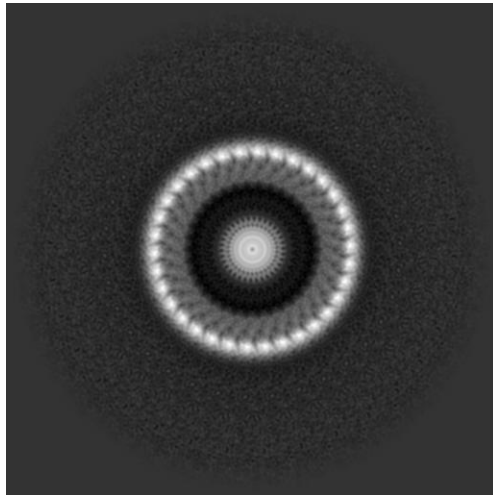

(c) Z Slice 256

Figure 1: Central slices of the input map in the three dimensions

Orthogonal slices of maximum variance of the input map

Results:

See Fig. 2.

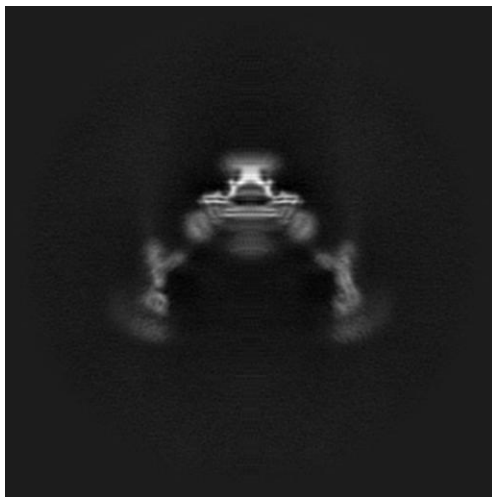

(a) X Slice 232

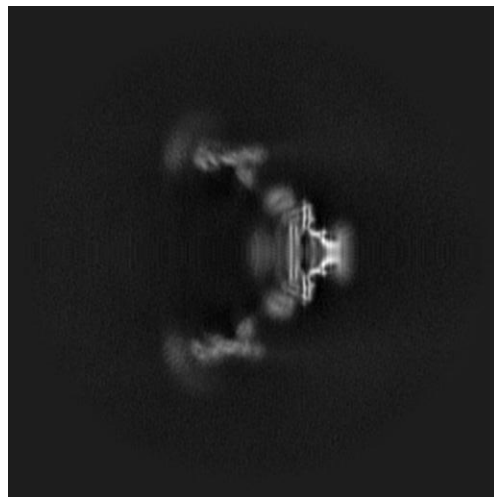

(b) Y Slice 232

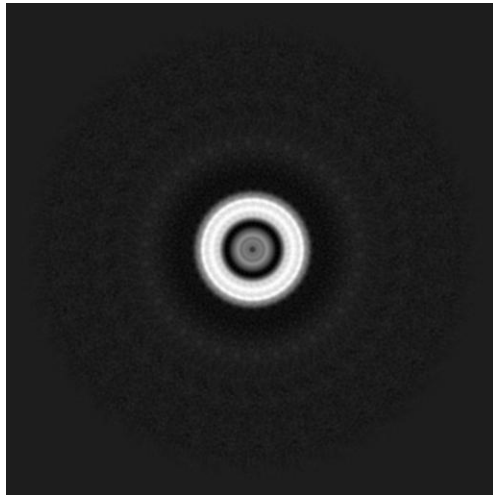

(c) Z Slice 308

Figure 2: Slices of maximum variation in the three dimensions

Orthogonal projections of the input map

Explanation:

In the projections there should not be stripes (this is an indication of directional overweighting, or angular attraction), and there should not be a dark halo around or inside the structure (this is an indication of incorrect CTF correction or the reconstruction of a biased map).

Results:

See Fig. 3.

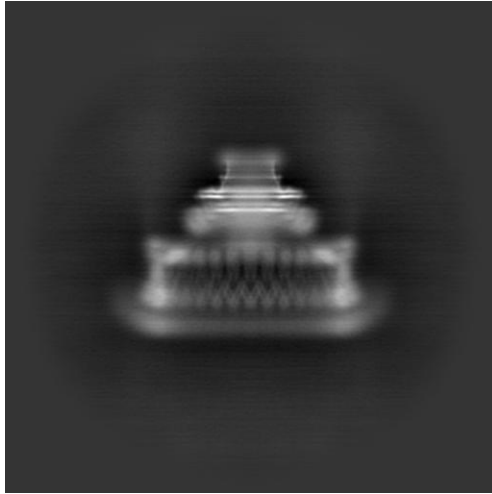

(a) X Projection

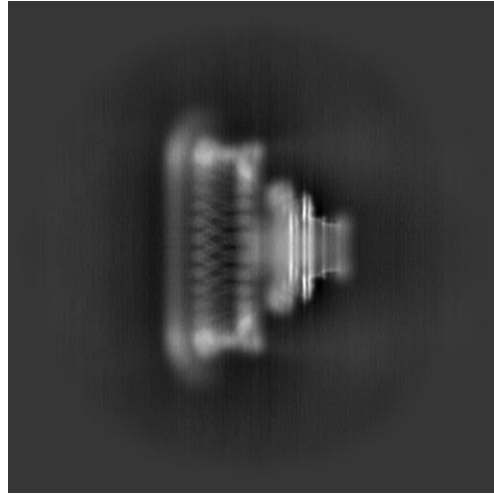

(b) Y Projection

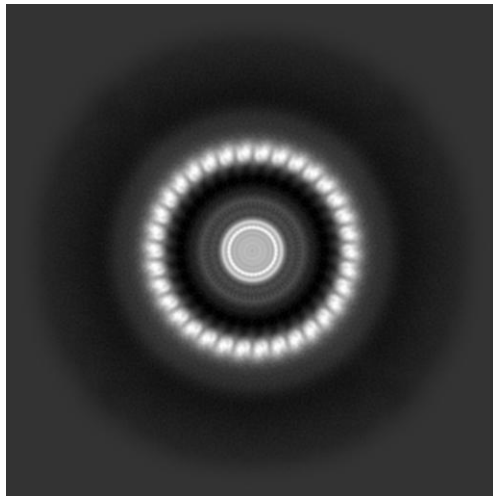

(c) Z Projection

Figure 3: Projections in the three dimensions

Isosurface views of the input map

Explanation:

An isosurface is the surface of all points that have the same gray value. In these views there should not be many artifacts or noise blobs around the map.

Results:
See Fig. 4.

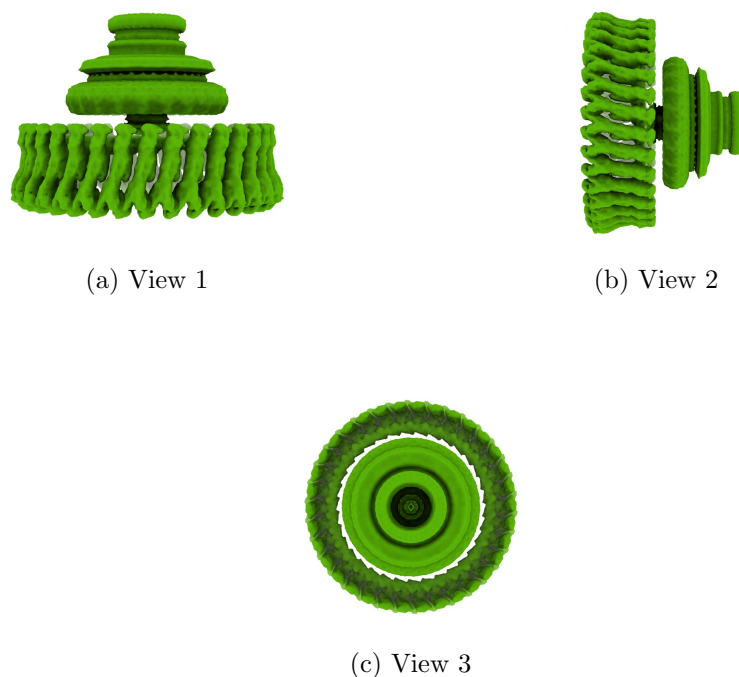

Figure 4: Isosurface at threshold=0.253000. Views generated by ChimeraX at a the following X, Y, Z angles: View 1 (0, -90, -90), View 2 (-90, 0, -90), View 3 (0, 0, 0).

Orthogonal slices of maximum variance of the mask with hard borders

Explanation:

The mask with hard borders has been calculated at the suggested threshold 0.253000, the largest connected component was selected, and then dilated by 2Å.

Results:
See Fig. 5.

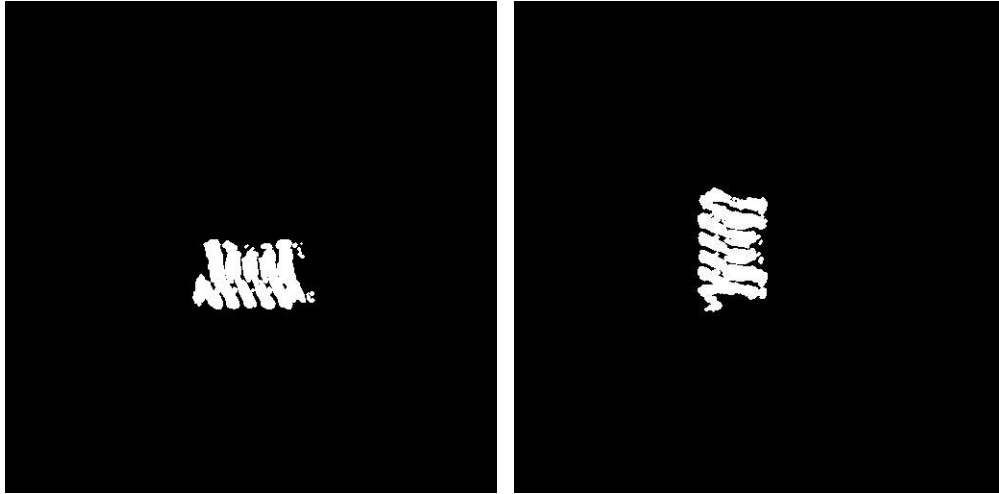

(a) X Slice 160

(b) Y Slice 159

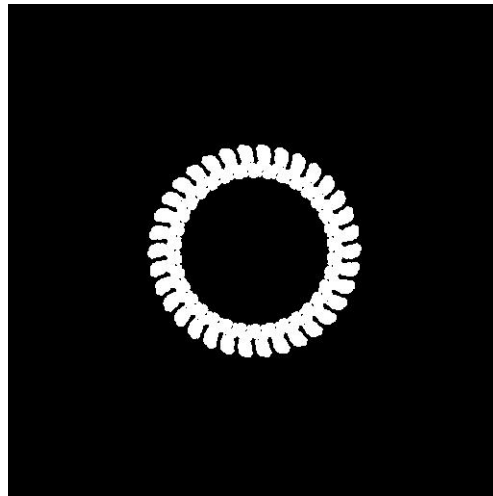

(c) Z Slice 246

Figure 5: Slices of maximum variation in the three dimensions of the mask with hard borders

Orthogonal slices of maximum variance of the mask with soft borders

Explanation:

The mask with soft borders has been calculated at the suggested threshold 0.253000, the largest connected component was selected, and then dilated by

2Å.

Results:
See Fig. 6.

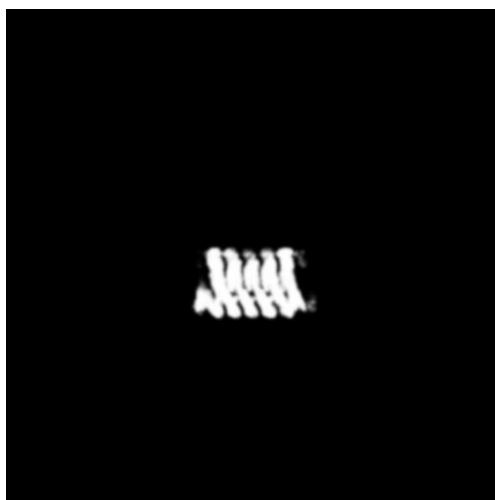

(a) X Slice 159

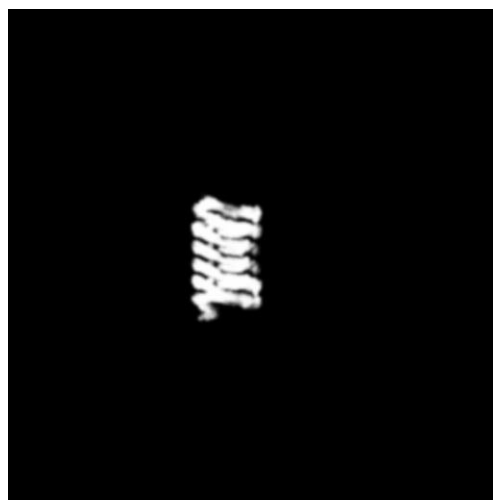

(b) Y Slice 159

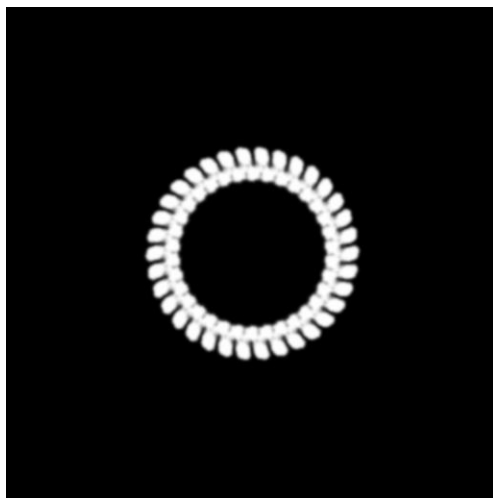

(c) Z Slice 246

Figure 6: Slices of maximum variation in the three dimensions of the mask with soft borders

2 Level 0 analysis

2.1 Level 0.a Mass analysis

Explanation:

The reconstructed map must be relatively well centered in the box, and there should be at least 30\AA (the exact size depends on the CTF) on each side to make sure that the CTF can be appropriately corrected.

Results:

The space from the left and right in X are 287.00 and 287.00\AA , respectively. There is a decentering ratio $(\text{abs}(\text{Right-Left})/\text{Size})\%$ of 0.00%

The space from the left and right in Y are 284.95 and 289.05\AA , respectively. There is a decentering ratio $(\text{abs}(\text{Right-Left})/\text{Size})\%$ of 0.39%

The space from the left and right in Z are 391.55 and 510.45\AA , respectively. There is a decentering ratio $(\text{abs}(\text{Right-Left})/\text{Size})\%$ of 11.33%

The center of mass is at $(x,y,z)=(256.00,255.00,284.66)$. The decentering of the center of mass $(\text{abs}(\text{Center})/\text{Size})\%$ is 0.00, 0.20, and 5.60, respectively.

Automatic criteria: The validation is OK if 1) the decentering and center of mass less than 20% of the map dimensions in all directions, and 2) the extra space on each direction is more than 20% of the map dimensions. For local reconstruction, focused refinement, or similar, warnings are expected.

STATUS: [OK](#)

2.2 Level 0.b Mask analysis

Explanation:

The map at the suggested threshold should have most of its mass concentrated in a single connected component. It is normal that after thresholding there are a few thousands of very small, disconnected noise blobs. However, their total mass should not exceed 10%. The raw mask (just thresholding) and the mask constructed for the analysis (thresholding + largest connected component + dilation) should significantly overlap. Overlap is defined by the overlapping coefficient $(\text{size}(\text{Raw AND Constructed})/\text{size}(\text{Raw}))$ that is a number between 0 and 1, the closer to 1, the more they agree.

Results:

Raw mask: At threshold 0.253000, there are 24 connected components with a total number of voxels of 901817 and a volume of 7769266.18 \AA^3 (see Fig. 7). The size and percentage of the total number of voxels for the raw mask are listed below (up to 95% of the mass or the first 100 clusters, whatever happens first), the list contains (No. voxels (volume in \AA^3), percentage, cumulated percentage):

(462808 (3987148.77), 51.32, 51.32)(438251 (3775587.15), 48.60, 99.92)

Number of components to reach 95% of the mass: 2

The average size of the remaining 22 components is 34.45 voxels (8.62 \AA^3). Their size go from 438251 voxels (3775587.15 \AA^3) to 1 voxels (8.62 \AA^3).

The slices of the raw mask can be seen in Fig. 7.

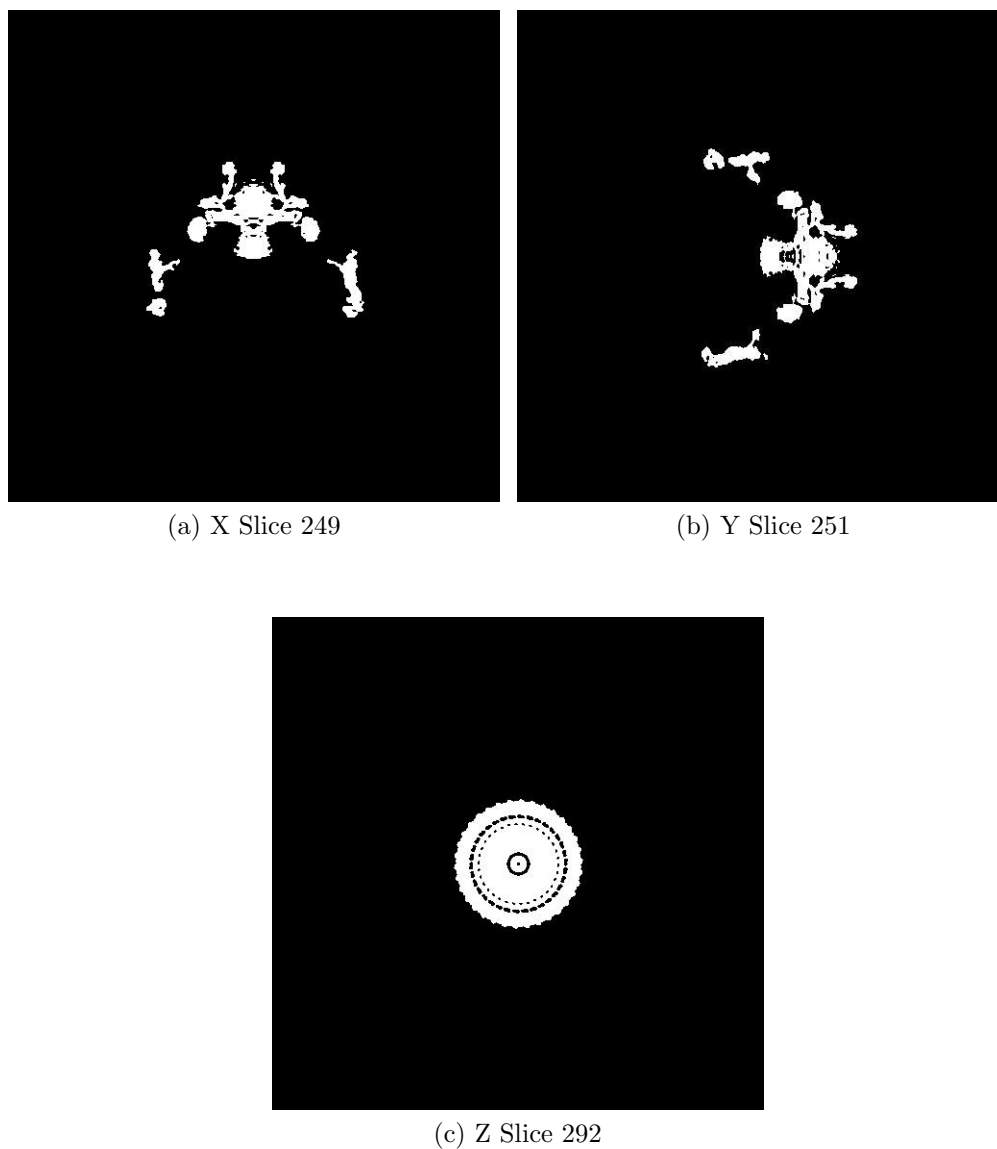

Figure 7: Maximum variance slices in the three dimensions of the raw mask

The following table shows the variation of the mass enclosed at different thresholds (see Fig. 8):

Threshold	Voxel mass	Molecular mass(kDa)	# Aminoacids
0.0437	3450000.00	24624.84	223862.18
0.0874	2553027.00	18222.57	165659.76
0.1312	1925076.00	13740.49	124913.54
0.1749	1436931.00	10256.29	93238.99
0.2186	1113694.00	7949.14	72264.92
0.2623	839965.00	5995.36	54503.30
0.3061	562217.00	4012.90	36480.90
0.3498	339230.00	2421.30	22011.82
0.3935	190179.00	1357.43	12340.26
0.4372	111384.00	795.02	7227.44
0.4810	78968.00	563.64	5124.04
0.5247	62416.00	445.50	4050.02
0.5684	48550.00	346.53	3150.29
0.6121	37106.00	264.85	2407.72
0.6559	27312.00	194.94	1772.21
0.6996	18920.00	135.04	1227.67
0.7433	12476.00	89.05	809.54
0.7870	8760.00	62.53	568.42
0.8307	5606.00	40.01	363.76
0.8745	3844.00	27.44	249.43
0.9182	2068.00	14.76	134.19
0.9619	1144.00	8.17	74.23
1.0056	318.00	2.27	20.63
1.0494	166.00	1.18	10.77

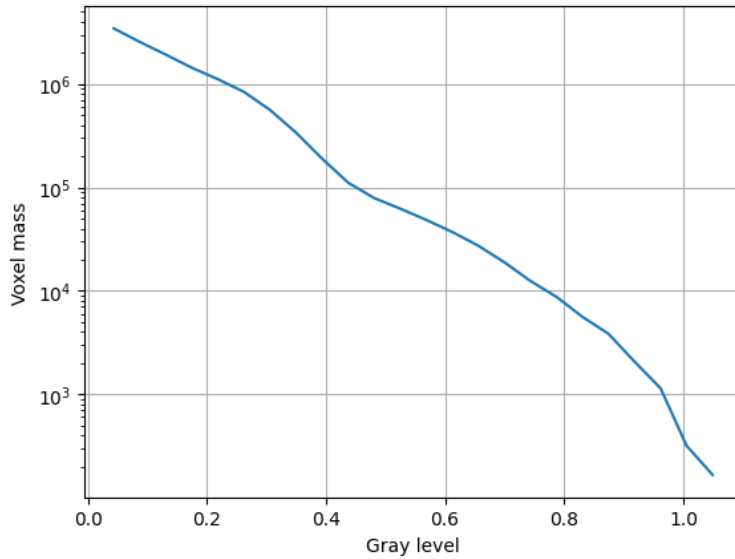

Figure 8: Voxel mass as a function of the gray level.

Constructed mask: After keeping the largest component of the previous mask and dilating it by 2\AA , there is a total number of voxels of 722520 and a volume of 6224600.11\AA^3 . The overlap between the raw and constructed mask is 0.51.

Automatic criteria: The validation is OK if 1) to keep 95% of the mass we need to keep at most 5 connected components; and 2) the average volume of the blobs outside the given threshold has a size smaller than 5\AA^3 ; and 3) the overlap between the raw mask and the mask constructed for the analysis is larger than 75%.

WARNINGS: 2 warnings

1. **There might be a problem with noise and artifacts, because the average noise blob has a volume of 8.615125\AA^3 .**
2. **There might be a problem in the construction of the mask, because the overlap is smaller than 0.75. A common reason is that the suggested threshold causes too many disconnected components.**

2.3 Level 0.c Background analysis

Explanation:

Background is defined as the region outside the macromolecule mask. The background mean should be zero, and the number of voxels with a very low or very high value (below 5 standard deviations of the noise) should be very small and they should be randomly distributed without any specific structure. Sometimes, you can see some structure due to the symmetry of the structure.

Results:

The null hypothesis that the background mean is 0 was tested with a one-sample Student's t-test. The resulting t-statistic and p-value were -411.86 and 0.000000, respectively.

The mean and standard deviation (sigma) of the background were -0.001113 and 0.031227. The percentage of background voxels whose absolute value is larger than 5 times the standard deviation is 0.69 % (see Fig. 9). The same percentage from a Gaussian would be 0.000057% (ratio between the two percentages: 11986.807441).

Slices of the background beyond 5*sigma can be seen in Fig. 9.

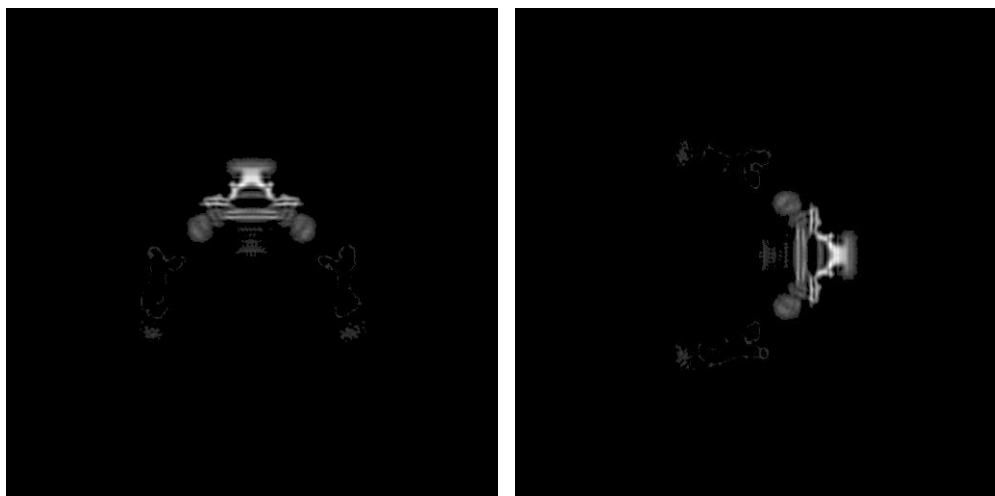

(a) X Slice 280

(b) Y Slice 231

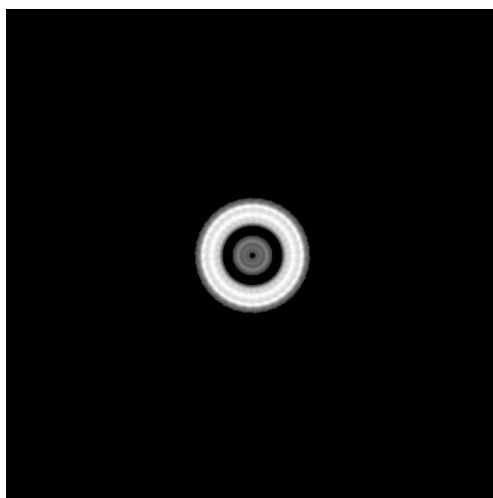

(c) Z Slice 308

Figure 9: Maximum variance slices in the three dimensions of the parts of the background beyond 5σ

Automatic criteria: The validation is OK if 1) the p-value of the null hypothesis that the background has 0 mean is larger than 0.001; and 2) the number of voxels above or below 5 sigma is smaller than 20 times the amount expected for a Gaussian with the same standard deviation whose mean is 0.

WARNINGS: 2 warnings

1. **The null hypothesis that the background mean is 0 has been rejected because the p-value of the comparison is smaller than 0.001**
2. **There is a significant proportion of outlier values in the background (cdf5 ratio=11986.81)**

2.4 Level 0.d B-factor analysis

Explanation:

The B-factor line (see this [link](#) for more details) fitted between 15\AA and the resolution reported should have a slope that is between 0 and 300 \AA^2 .

Results:

Fig. 10 shows the logarithm (in natural units) of the structure factor (the module squared of the Fourier transform) of the experimental map, its fitted line, and the corrected map. The estimated B-factor was -337.4. The fitted line was $\log(|F|^2) = -84.4/R^2 + (-12.2)$.

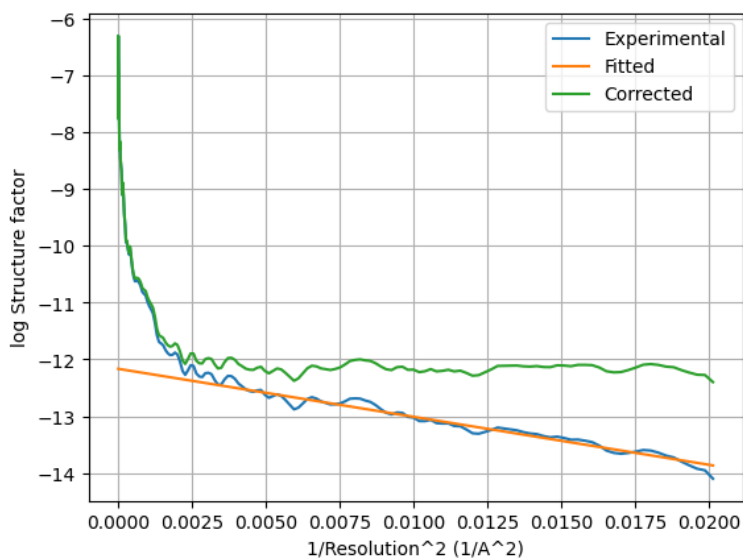
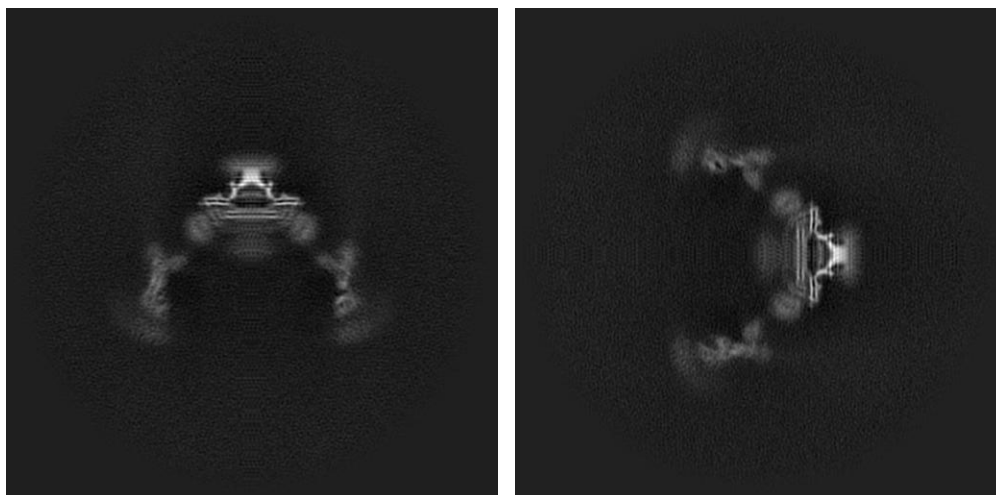
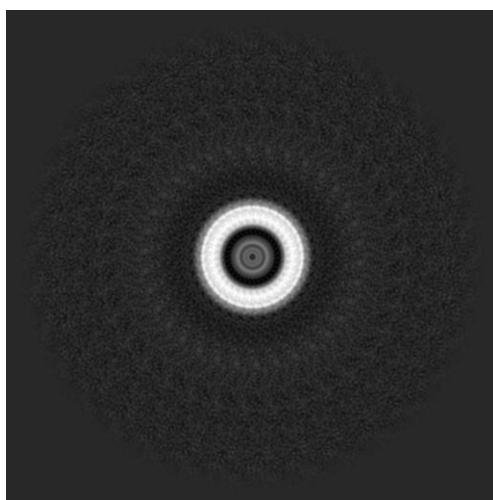

Figure 10: Guinier plot. The X-axis is the square of the inverse of the resolution in Å.



(a) X Slice 280

(b) Y Slice 231



(c) Z Slice 308

Figure 11: Slices of maximum variation in the three dimensions of the B-factor corrected map

Automatic criteria: The validation is OK if the B-factor is in the range $[-300,0]$.

WARNINGS: 1 warnings

1. **The B-factor is out of the interval [-300,0].**

2.5 Level 0.e Local resolution with DeepRes

Explanation:

DeepRes (see this [link](#) for more details) measures the local resolution using a neural network that has been trained on the appearance of atomic structures at different resolutions. Then, by comparing the local appearance of the input map to the appearance of the atomic structures a local resolution label can be assigned.

Results:

ERROR: The protocol failed.

STATUS: Could not be measured

2.6 Level 0.f Local B-factor

Explanation:

LocBfactor (see this [link](#) for more details) estimates a local resolution B-factor by decomposing the input map into a local magnitude and phase term using the spiral transform.

Results:

Fig. 12 shows the histogram of the local B-factor according to LocBfactor. Some representative percentiles are:

Percentile	Local B-factor (\AA^{-2})
2.5%	-1491.55
25%	-1154.81
50%	-981.84
75%	-813.27
97.5%	-523.04

Fig. 13 shows some representative views of the local B-factor.

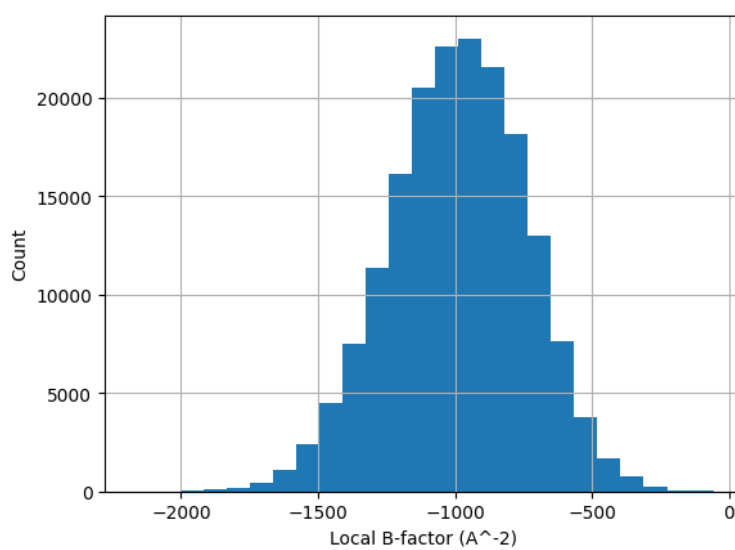
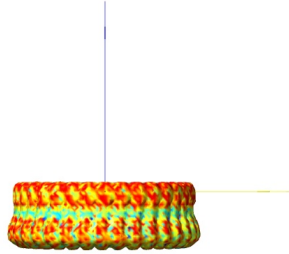
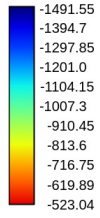
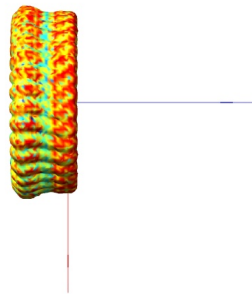
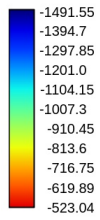

Figure 12: Histogram of the local B-factor according to LocBfactor.



(a) View 1



(b) View 2

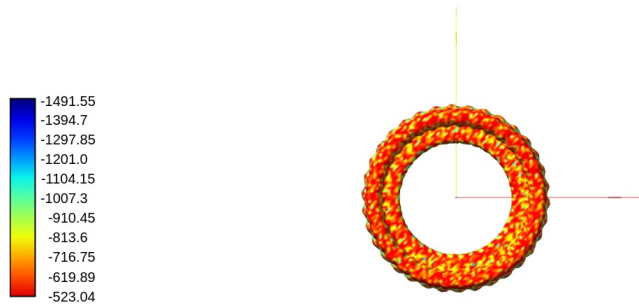

(c) View 3

Figure 13: Local B-factor according to LocBfactor. Views generated by ChimeraX at a the following X, Y, Z angles: View 1 (0, -90, -90), View 2 (-90, 0, -90), View 3 (0, 0, 0).

Automatic criteria: The validation is OK if the median B-factor is in the range [-300,0].

WARNINGS: 1 warnings

1. **The median B-factor is out of the interval [-300,0]**

2.7 Level 0.g Local Occupancy

Explanation:

LocOccupancy (see this [link](#) for more details) estimates the occupancy of a voxel by the macromolecule.

Results:

Fig. 14 shows the histogram of the local occupancy according to LocOccupancy. Some representative percentiles are:

Percentile	Local Occupancy [0-1]
2.5%	0.31
25%	0.62
50%	0.81
75%	0.88
97.5%	1.00

Fig. 15 shows some representative views of the local occupancy.

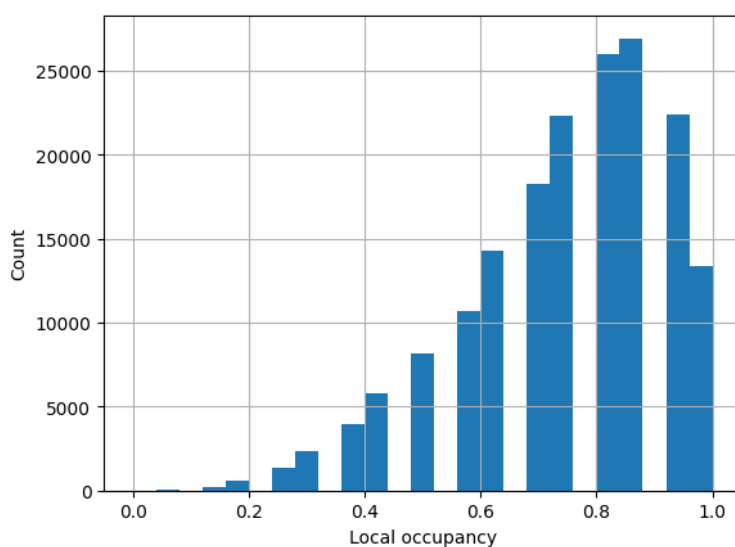
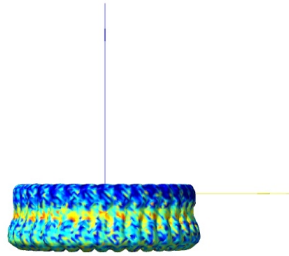
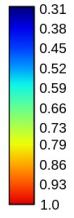
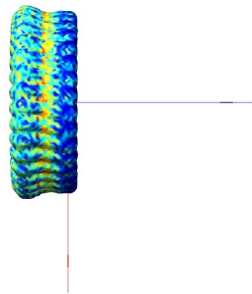
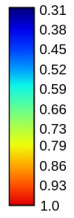

Figure 14: Histogram of the local occupancy according to LocOccupancy.



(a) View 1



(b) View 2

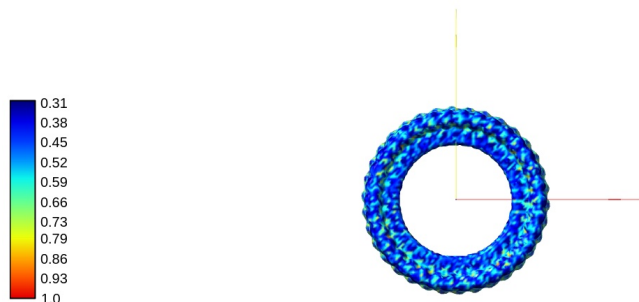

(c) View 3

Figure 15: Local occupancy according to LocOccupancy. Views generated by ChimeraX at the following X, Y, Z angles: View 1 (0, -90, -90), View 2 (-90, 0, -90), View 3 (0, 0, 0).

Automatic criteria: The validation is OK if the median occupancy is larger than 50%.

STATUS: OK

2.8 Level 0.h Hand correction

Explanation:

Deep Hand (see this [link](#) for more details) determines the correction of the hand for those maps with a resolution smaller than 5Å. The method calculates a value between 0 (correct hand) and 1 (incorrect hand) using a neural network to assign its hand.

Results:

This method cannot be applied to maps with a resolution worse than 5Å.

STATUS: Does not apply

3 Half maps

Half map 1: emd_44254_half_map_1.map

SHA256 hash: 20ed0e0da12f75e70f704607464287f60d5a0b9b9372e1a3646662e1c1b32c0d

Half map 2: emd_44254_half_map_2.map

SHA256 hash: 16aa72f643223a71e4736f47a6112ed30f2c8e03b3850b8677609c4e1c05d6eb

Slices of the first half map can be seen in Fig. 16.

Slices of the second half map can be seen in Fig. 17.

Slices of the difference between both maps can be seen in Fig. 18. There should not be any structure in this difference. Sometimes some patterns are seen if the map is symmetric.

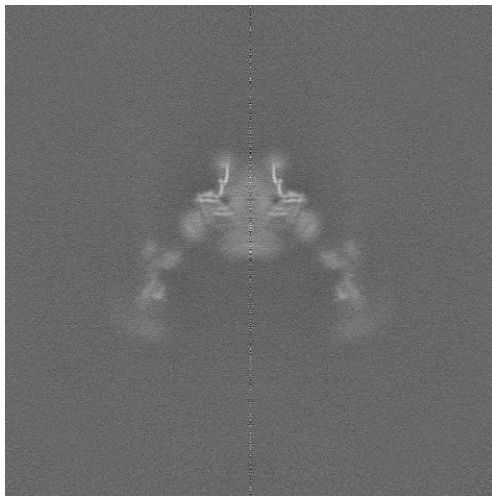

(a) X Slice 256

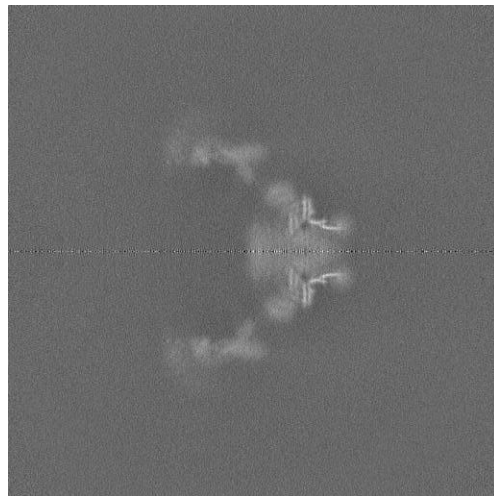

(b) Y Slice 255

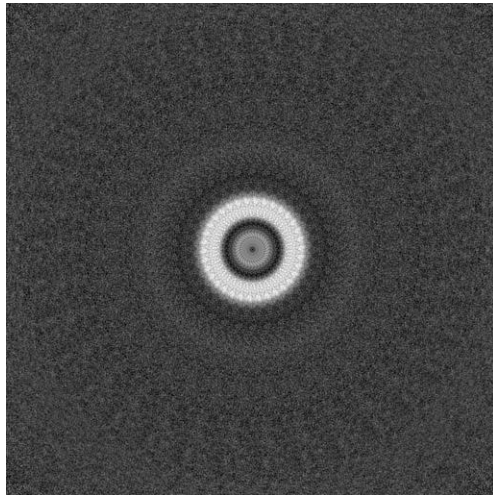

(c) Z Slice 308

Figure 16: Slices of maximum variation in the three dimensions of Half 1

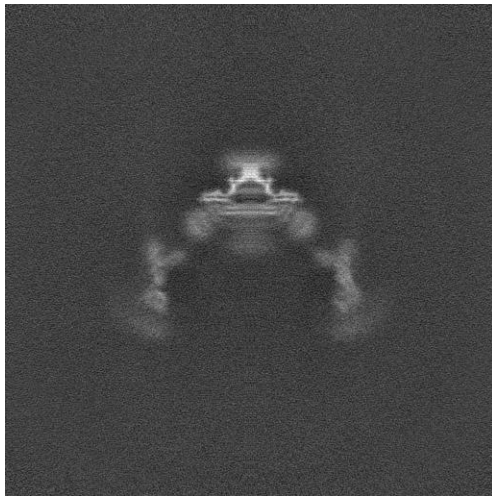

(a) X Slice 232



(b) Y Slice 255

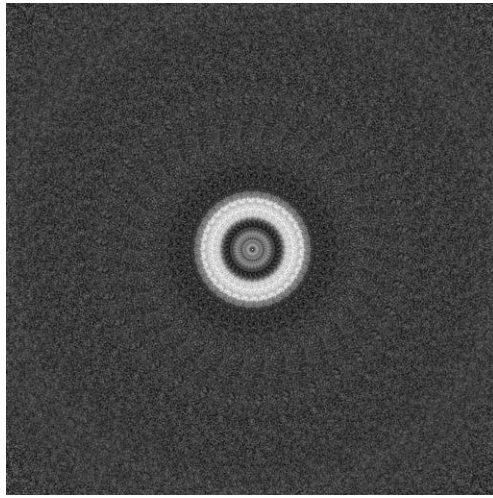

(c) Z Slice 308

Figure 17: Slices of maximum variation in the three dimensions of Half 2

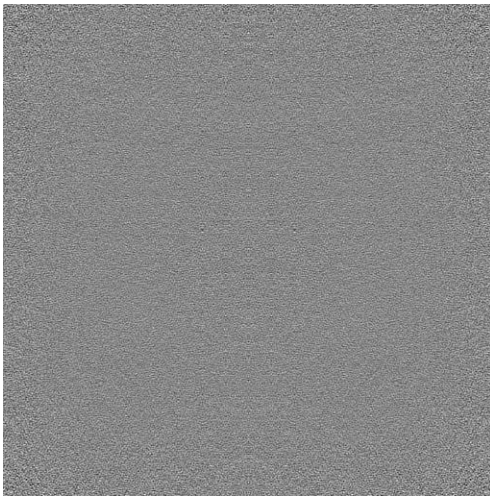

(a) X Slice 0

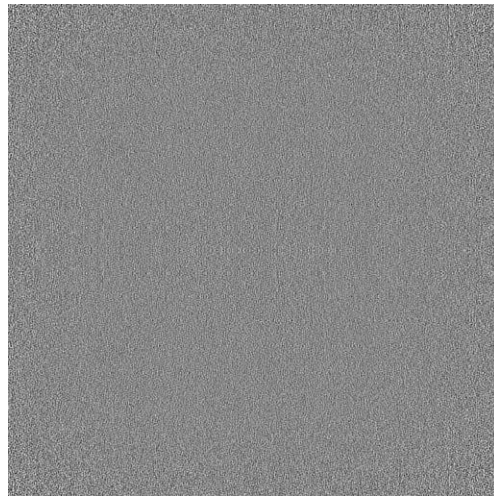

(b) Y Slice 511

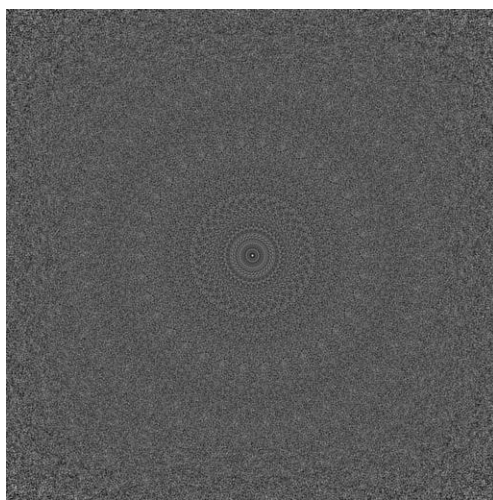

(c) Z Slice 0

Figure 18: Slices of maximum variation in the three dimensions of the difference Half1-Half2.

4 Level 1 analysis

4.1 Level 1.a Global resolution

Explanation: The Fourier Shell Correlation (FSC) between the two half maps is the most standard method to determine the global resolution of a map. However, other measures exist such as the Spectral Signal-to-Noise Ratio and the Differential Phase Residual. There is a long debate about the right thresholds for these measures. Probably, the most clear threshold is the one of the SSNR (SSNR=1). For the DPR we have chosen 103.9° and for the FSC, the standard 0.143. For a deep discussion of all these thresholds, see this [link](#). Note that these thresholds typically result in resolution values that are at the lower extreme of the local resolution range, meaning that this resolution is normally in the first quarter. It should not be understood as the average resolution of the map.

Except for the noise, the FSC and DPR should be approximately monotonic. They should not have any “coming back” behavior. If they have, this is typically due to the presence of a mask in real space or non-linear process-

ing.

Results:

Fig. 19 shows the FSC and the 0.143 threshold. The resolution according to the FSC is 10.61Å. The map information is well preserved (FSC>0.9) up to 36.22Å.

Fig. 20 shows the DPR and the 103.9° threshold. The resolution according to the DPR is 9.20Å.

Fig. 21 shows the SSNR and the SSNR=1 threshold. The resolution according to the SSNR is 13.18Å.

The mean resolution between the three methods is 11.00Å and its range is within the interval [9.20,13.18]Å.

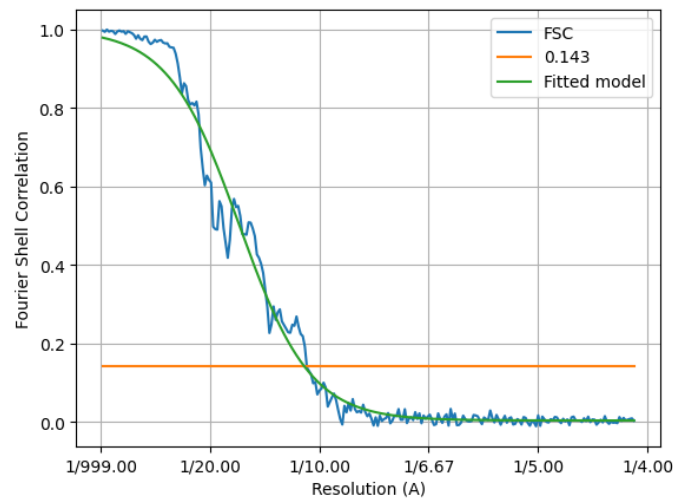

Figure 19: Fourier Shell correlation between the two halves.

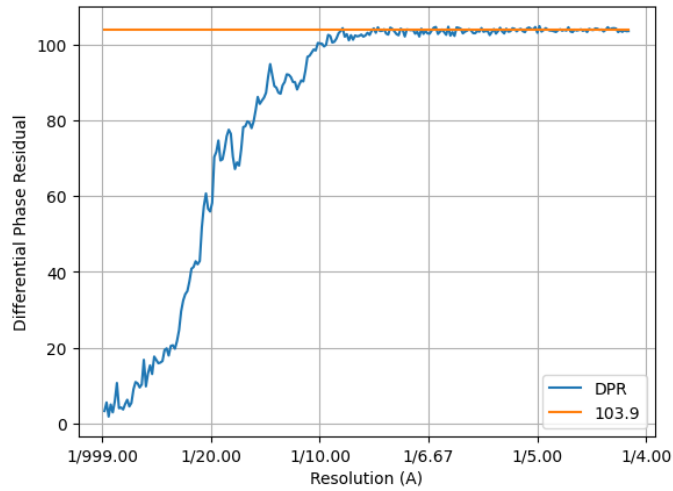

Figure 20: Differential Phase Residual between the two halves.

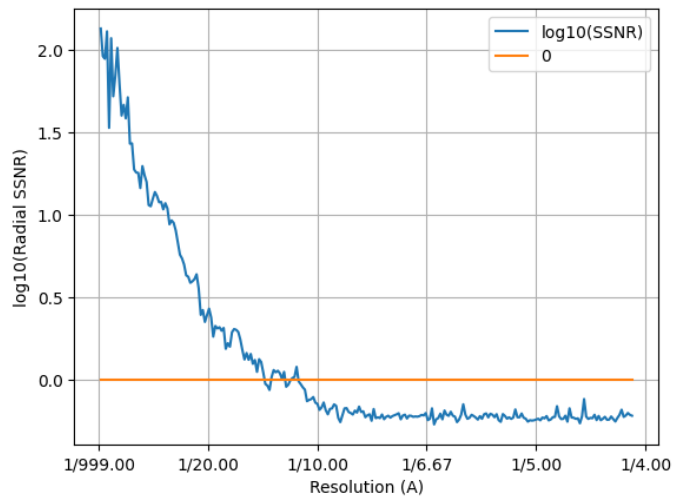

Figure 21: Spectral Signal-to-Noise Ratio estimated from the two halves.

Automatic criteria: The validation is OK if the user provided resolution is larger than 0.8 times the resolution estimated by 1) FSC, 2) DPR, and 3) SSNR.

WARNINGS: 3 warnings

1. **The reported resolution, 7.01 Å, is particularly high with respect to the resolution calculated by the FSC, 10.61 Å**
2. **The reported resolution, 7.01 Å, is particularly high with respect to the resolution calculated by the DPR, 9.20Å.**
3. **The reported resolution, 7.01 Å, is particularly high with respect to the resolution calculated by the SSNR, 13.18Å.**

4.2 Level 1.b FSC permutation

Explanation:

This method (see this [link](#) for more details) calculates a global resolution by formulating a hypothesis test in which the distribution of the FSC of noise is calculated from the two maps.

Results:

The resolution at 1% of FDR was 9.2. Fig. 22 shows the estimated FSC and resolution.

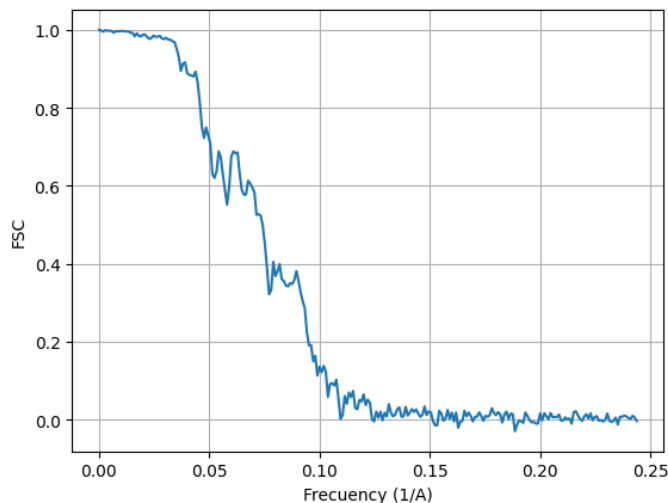

Figure 22: FSC and resolution estimated by a permutation test.

Automatic criteria: The validation is OK if the user provided resolution is larger than 0.8 times the resolution estimated by FSC permutation.

WARNINGS: 1 warnings

1. **The reported resolution, 7.01 Å, is particularly high with respect to the resolution calculated by the FSC permutation, 9.21 Å**

4.3 Level 1.c Local resolution with Blocres

Explanation:

This method (see this [link](#) for more details) computes a local Fourier Shell Correlation (FSC) between the two half maps.

Results:

Fig. 23 shows the histogram of the local resolution according to Blocres. Some representative percentiles are:

Percentile	Resolution(Å)
2.5%	7.86
25%	8.81
50%	10.70
75%	12.48
97.5%	14.21

The reported resolution, 7.01 Å, is at the percentile 0.0. Fig. 24 shows some representative views of the local resolution.

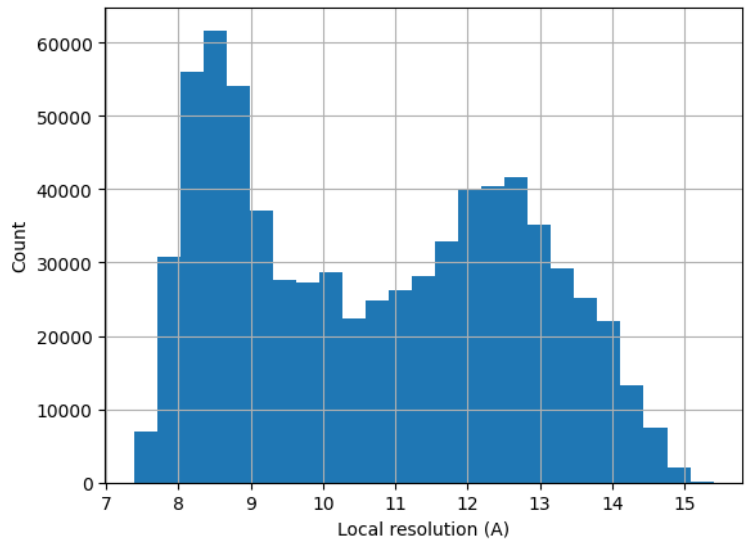
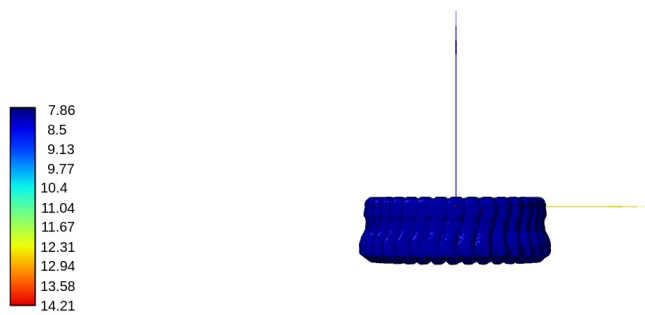
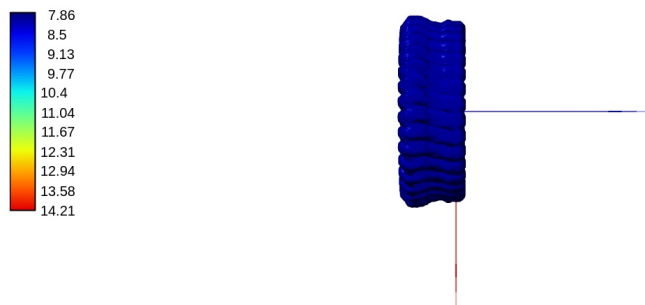

Figure 23: Histogram of the local resolution according to blocres.



(a) View 1



(b) View 2

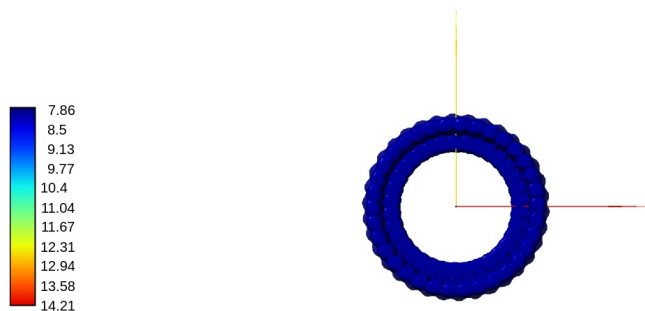

(c) View 3

Figure 24: Local resolution according to Blocres. Views generated by ChimeraX at the following X, Y, Z angles: View 1 (0, -90, -90), View 2 (-90, 0, -90), View 3 (0, 0, 0).

Automatic criteria: The validation is OK if the percentile of the user provided resolution is larger than 0.1% of the percentile of the local resolution as estimated by BlocRes.

WARNINGS: 1 warnings

1. **The reported resolution, 7.01 Å, is particularly high with respect to the local resolution distribution. It occupies the 0.00 percentile**

4.4 Level 1.d Local resolution with Resmap

Explanation:

This method (see this [link](#) for more details) is based on a test hypothesis testing of the superiority of signal over noise at different frequencies.

Results:

ERROR: The protocol failed.

STATUS: Could not be measured

4.5 Level 1.e Local resolution with MonoRes

Explanation:

MonoRes (see this [link](#) for more details) evaluates the local energy of a point with respect to the distribution of energy in the noise. This comparison is performed at multiple frequencies and for each one, the monogenic transformation separates the amplitude and phase of the input map. Then the energy of the amplitude within the map is compared to the amplitude distribution observed in the noise, and a hypothesis test is run for every voxel to check if its energy is significantly above the level of noise.

Results:

Fig. 25 shows the histogram of the local resolution according to MonoRes. Some representative percentiles are:

Percentile	Resolution(\AA)
2.5%	8.12
25%	13.05
50%	16.73
75%	20.84
97.5%	25.81

The reported resolution, 7.01 \AA , is at the percentile 0.7. Fig. 26 shows some representative views of the local resolution

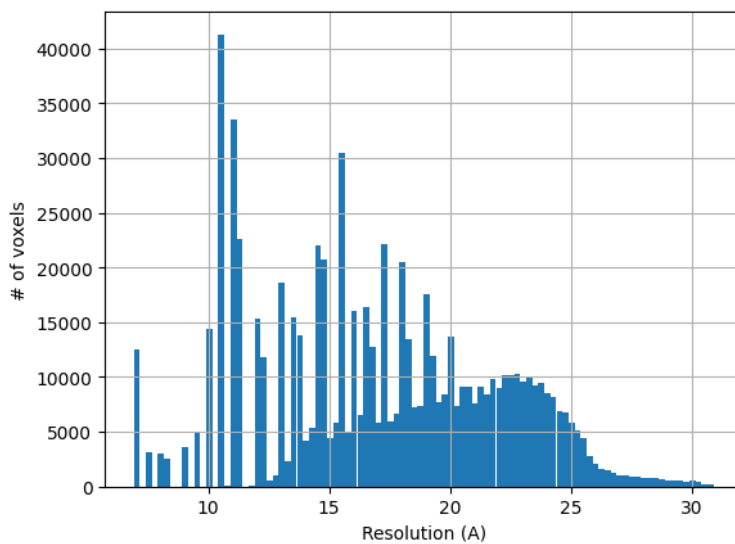
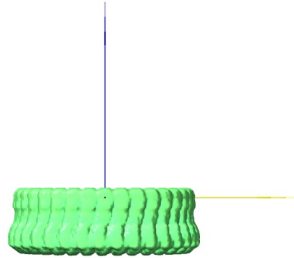
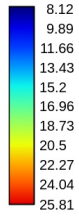
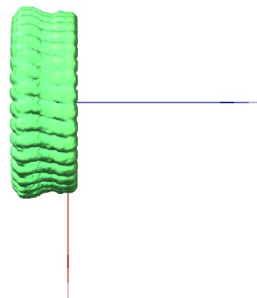
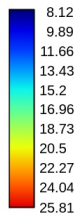

Figure 25: Histogram of the local resolution according to MonoRes.



(a) View 1



(b) View 2

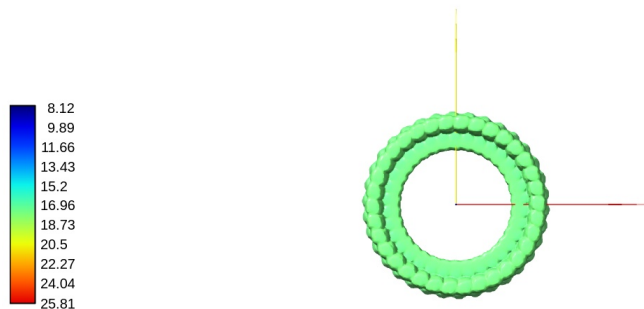

(c) View 3

Figure 26: Local resolution according to MonoRes. Views generated by ChimeraX at a the following X, Y, Z angles: View 1 (0, -90, -90), View 2 (-90, 0, -90), View 3 (0, 0, 0).

Automatic criteria: The validation is OK if the percentile of the user provided resolution is larger than 0.1% of the percentile of the local resolution as estimated by MonoRes.

STATUS: OK

4.6 Level 1.f Local and directional resolution with MonoDir

Explanation:

MonoDir (see this [link](#) for more details) extends the concept of local resolution to local and directional resolution by changing the shape of the filter applied to the input map. The directional analysis can reveal image alignment problems.

The histogram of best resolution voxels per direction (Directional Histogram 1D) shows how many voxels in the volume have their maximum resolution in that direction. Directions are arbitrarily numbered from 1 to N. This histogram should be relatively flat. We perform a Kolmogorov-Smirnov test to check its uniformity. If the null hypothesis is rejected, then the di-

rectional resolution is not uniform. It does not mean that it is wrong, and it could be caused by several reasons: 1) the angular distribution is not uniform, 2) there are missing directions, 3) there is some anisotropy in the data (including some preferential directional movement).

Ideally, the radial average of the minimum, maximum, and average resolution at each voxel (note that these are spatial radial averages) should be flat and as low as possible. If they show some slope, this is associated with inaccuracies in the angular assignment. These averages make sense when the shells are fully contained within the protein. As the shells approach the outside of the protein, these radial averages make less sense.

Results:

Fig. 27 shows the 1D directional histogram and Fig. 28 the 2D directional histogram. We compared the 1D directional histogram to a uniform distribution using a Kolmogorov-Smirnov test. The D statistic was 0.056958, and the p-value of the null hypothesis 0.000000.

The radial average of the minimum, maximum and average resolution at each voxel is shown in Fig. 29. The overall mean of the directional resolution is 10.27

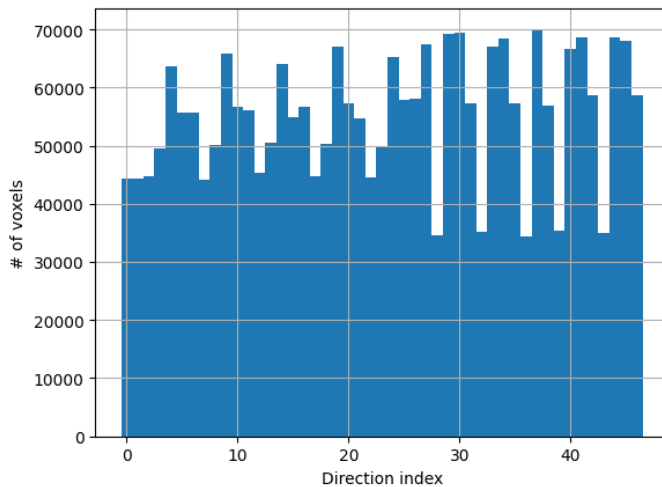

Figure 27: Histogram 1D of the best direction at each voxel.

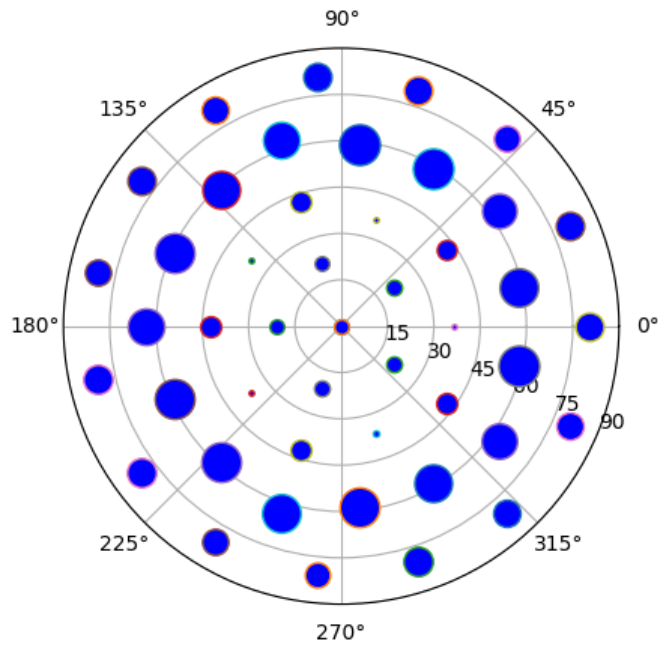

Figure 28: Histogram 2D of the best direction at each voxel. The azimuthal rotation is circular, while the tilt angle is the radius. The size of the point is proportional to the number of voxels whose maximum resolution is in that direction (this count can be seen in Fig. 27).

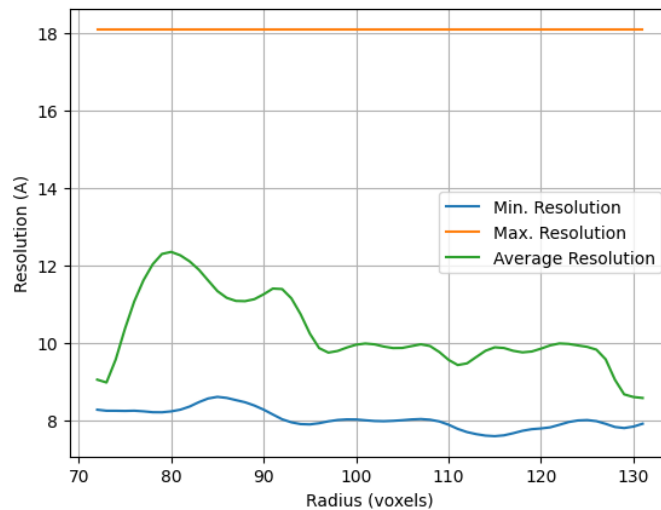

Figure 29: Radial averages (in space) of the minimum, maximum and average resolution at each voxel.

Automatic criteria: The validation is OK if 1) the null hypothesis that the directional resolution is not uniform is not rejected with a threshold of 0.001 for the p-value, and 2) the resolution provided by the user is not smaller than 0.8 times the average directional resolution.

WARNINGS: 2 warnings

1. **The distribution of best resolution is not uniform in all directions. The associated p-value is 0.000000.**
2. **The resolution reported by the user, 7.01Å, is at least 80% smaller than the average directional resolution, 10.27 Å.**

4.7 Level 1.g Fourier Shell Occupancy

Explanation:

This method (see this [link](#) for more details) calculates the anisotropy of the energy distribution in Fourier shells. This is an indirect measure of anisotropy of the angular distribution or the presence of heterogeneity. A natural threshold for this measure is 0.5. However, 0.9 and 0.1 are also interesting values that define the frequency at which the occupancy is 90% and 10%, respectively. This region is shaded in the plot.

Results:

Fig. 30 shows the Fourier Shell Occupancy and its anisotropy. The directional resolution is shown in Fig. 31. The resolution according to the FSO is 8.69\AA . Fourier shells are occupied at between 90 and than 10% in the range $[10.87, 7.63]\text{\AA}$.

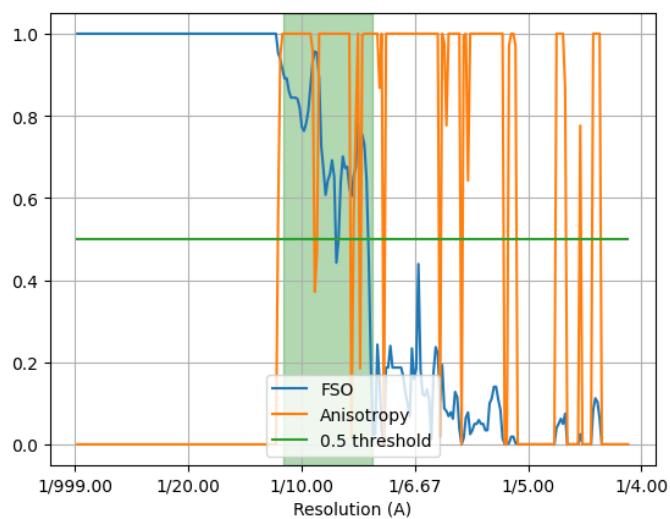

Figure 30: FSO and anisotropy.

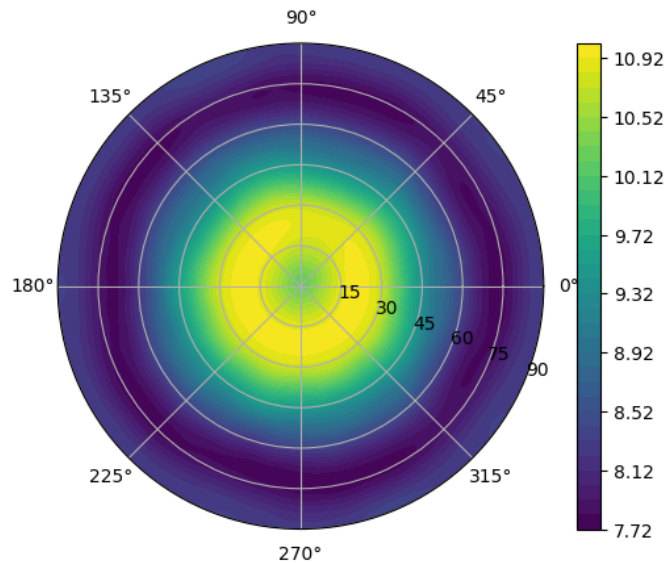

Figure 31: Directional resolution in the projection sphere.

Automatic criteria: The validation is OK if the resolution provided by the user is not smaller than 0.8 times the resolution estimated by the first cross of FSO below 0.5.

STATUS: OK

4.8 Level 1.h Fourier Shell Correlation 3D

Explanation:

This method (see this [link](#) for more details) analyzes the FSC in different directions and evaluates its homogeneity.

Results:

Fig. 32 shows the FSCs in X, Y, Z, and the global FSC. Fig. 33 shows the global FSC and the histogram of the directional FSC. Finally, Fig. 34 shows the rotational average of the map power in Fourier space. The FSC 3D resolutions at a 0.143 threshold in X, Y, and Z are 1.00, 1.00, and 1.19 Å, respectively. The global resolution at the same threshold is 1.04 Å. The resolution range is [1.00, 1.19]Å.

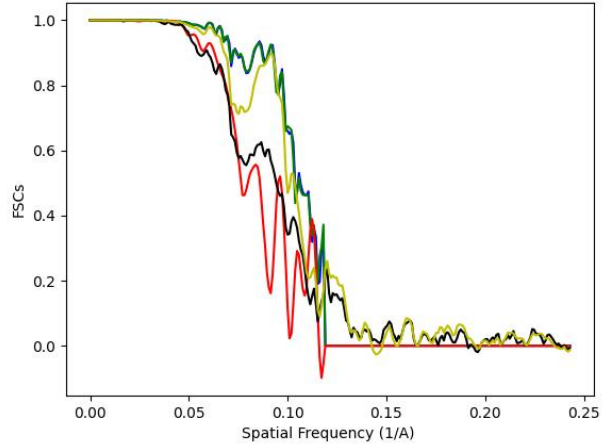

Figure 32: FSC in X, Y, Z, the global FSC, and the Average Cosine Phase.

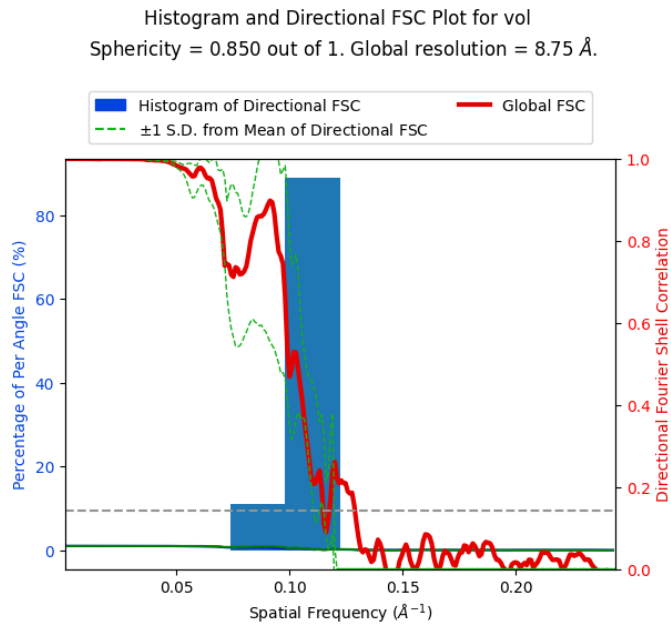

Figure 33: Global FSC and histogram of the directional FSC.

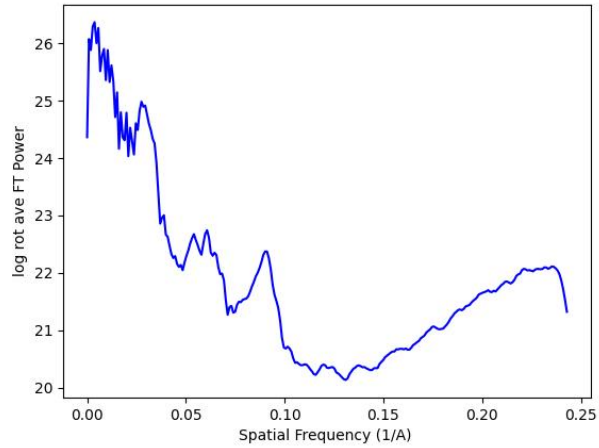

Figure 34: Logarithm of the radial average of the input map power in Fourier space.

Automatic criteria: The validation is OK if the resolution provided by the user is not smaller than 0.8 the resolution estimated by the first cross of the global directional FSC below 0.143.

STATUS: OK